

PCB Mount Fuse Block

Contact Parts	Copper Alloy 0.4mm thick
Finish	Tin plated
Body Material	Thermoplastic UL94V-0
Rated Current	6.3A

For 5.2 x 20mm Fuses

Ordering P/N P8029-01

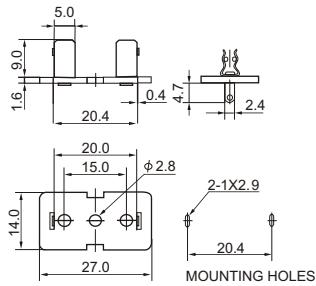

Ordering P/N P8029-02

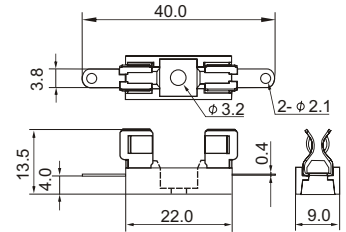

Ordering P/N P8029-03

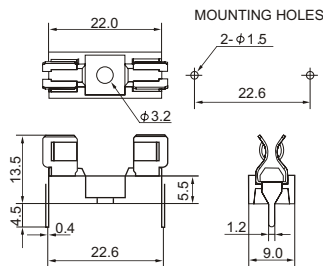

Ordering P/N P8029-04

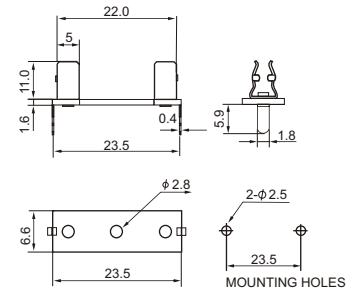

For 6.35 x 32mm Fuses

Ordering P/N P8030-01

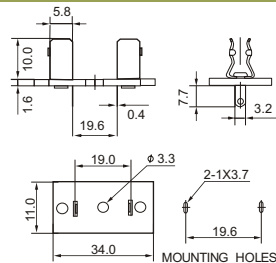

PCB Mount Clips for ø 6.35mm Fuses

Material	Copper Alloy
Material Thickness	0.5 mm
Finish	Tin Plated
Rated Current	8A

Ordering P/N P8038-01

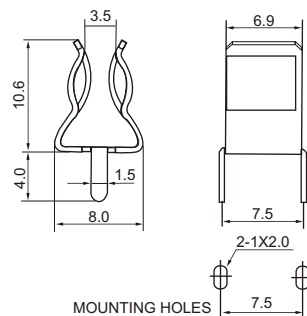

Ordering P/N P8038-02

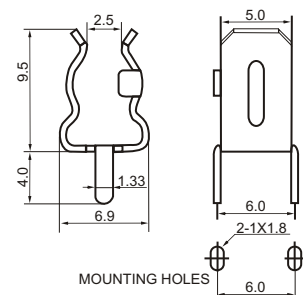

PCB Mount Clips for \varnothing 5.2mm Fuses

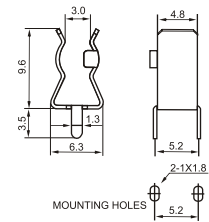
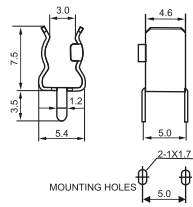

Ordering P/N P8035-01

Material	Copper Alloy
Material Thickness	0.4 mm
Finish	Tin Plated
Rated Current	7A

Ordering P/N P8035-02

Material	Copper Alloy
Material Thickness	0.4 mm
Finish	Tin Plated
Rated Current	7A

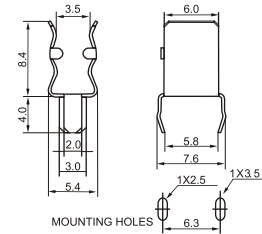
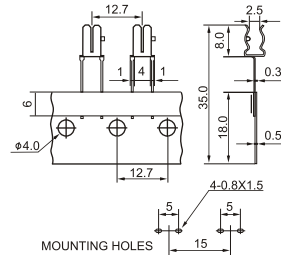

Ordering P/N P8035-03

Material	Copper Alloy
Material Thickness	0.3 mm
Finish	Tin Plated
Rated Current	5A
Remarks	Taping

Ordering P/N P8035-04

Material	Copper Alloy
Material Thickness	0.3 mm
Finish	Tin Plated
Rated Current	5A

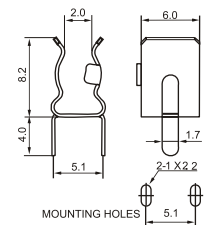
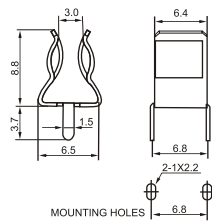

Ordering P/N P8035-05

Material	Copper Alloy
Material Thickness	0.4 mm
Finish	Tin Plated
Rated Current	7A

Ordering P/N P8035-06

Material	Copper Alloy
Material Thickness	0.3 mm
Finish	Tin Plated
Rated Current	5A

PCB Mount Clips for \varnothing 5.2mm Fuses

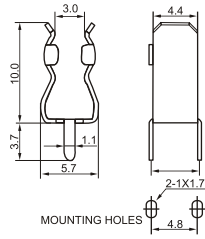

Ordering P/N P8035-07

Material	Copper Alloy
Material Thickness	0.4 mm
Finish	Tin Plated
Rated Current	7A

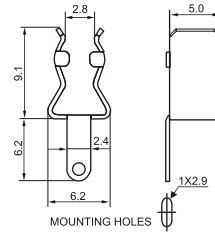

Ordering P/N P8035-08

Material	Copper Alloy
Material Thickness	0.4 mm
Finish	Tin Plated
Rated Current	7A

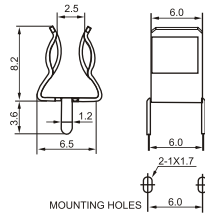

Ordering P/N P8035-09

Material	Copper Alloy
Material Thickness	0.4 mm
Finish	Tin Plated
Rated Current	7A

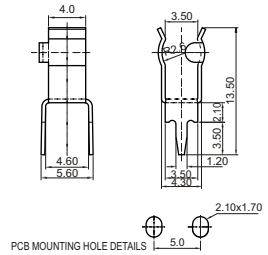

Ordering P/N P8035-10-29

Material	Copper Alloy
Material Thickness	0.4 mm
Finish	Tin Plated
Rated Current	7A

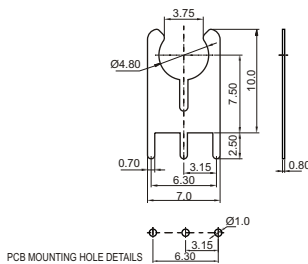

Ordering P/N P8035-11-18

Material	Copper Alloy
Material Thickness	0.8 mm
Finish	Tin Plated
Rated Current	10A

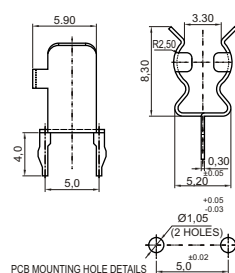

Ordering P/N P8035-12

Material	Copper Alloy
Material Thickness	0.3 mm
Finish	Tin Plated
Rated Current	5A